



## Motor Genie MCA™

### User Guide

Product # 50102 (English)  
Rev. January 15, 2024 (English)

## **Table of Contents**

<b>Table of Contents</b> .....	<b>2</b>
<b>Quickstart Guide</b> .....	<b>4</b>
<b>1. Introduction</b> .....	<b>6</b>
<b>2. Safety Warnings and Precautions</b> .....	<b>7</b>
<b>3. Standard Equipment &amp; Warranty</b> .....	<b>9</b>
3.1 Equipment Contents .....	9
3.2 Warranty.....	9
3.3 Accessories .....	9
3.4 Training & Support .....	9
<b>4. Instrument Features</b> .....	<b>10</b>
4.1 Exterior .....	10
4.1.1 <i>Front Panel</i> .....	10
4.1.2 <i>Connection Ports</i> .....	10
4.2 Batteries and Charger .....	11
4.3 Test Frequency.....	11
4.4 Temporary Memory.....	12
4.5 Specifications.....	13
<b>5. Operation Instructions</b> .....	<b>14</b>
5.1 Basic Functions .....	14
5.2 Main Menu.....	16
5.3 Testing Functions.....	17
5.3.1 <i>Resistance Test</i> .....	17
5.3.2 <i>Insulation Test</i> .....	18
5.3.3 <i>Motor Genie Test</i> .....	19
5.4 Setup Menu.....	21
5.4.1 <i>View Test Records</i> .....	22
5.4.2 <i>Set Date/Time</i> .....	22
5.4.3 <i>Manual Test Operation</i> .....	23
5.4.4 <i>Calibration</i> .....	24
5.5 Measurement Screen Controls.....	25
5.6 Results Screen.....	25
<b>6. Good, Warn, Bad Analysis Measurement Guide</b> .....	<b>27</b>
<b>7. Collecting the Complete Set of Motor Test Data</b> .....	<b>28</b>

<b>8. Typical Motor Testing Procedures</b> .....	<b>30</b>
8.1 Resistance Test Instructions.....	31
8.2 Insulation Test Instructions.....	32
8.3 Motor Genie Test Instructions.....	35
8.3.1 Realtime Values.....	36
8.4 Rotor Compensated Test Instructions (MAX Z).....	37
8.5 Cable Testing Instructions.....	38
<b>9. Manual Test Mode</b> .....	<b>39</b>
<b>10. Condition Calculator App</b> .....	<b>40</b>
10.1 Mapping Test Data to the App.....	41
<b>11. Troubleshooting</b> .....	<b>42</b>
<b>12. Available Upgrades</b> .....	<b>42</b>
<b>13. Glossary</b> .....	<b>43</b>
<b>14. Contact Information</b> .....	<b>43</b>
<b>15. Notice of Service/Trademark Rights</b> .....	<b>43</b>

# Quickstart Guide



## Motor Genie® MCA™ Quickstart Guide



TURN DATA INTO DIAGNOSIS

Download the Motor Genie® Condition Calculator app



FOR SQUIRREL CAGE ROTOR MOTORS <1000V

### FUNCTIONS



**MOTOR GENIE TEST**

Performs an evaluation of the motor winding system. With the phase-to-phase results of impedance, phase angle and current frequency response, the MG algorithm conducts a phase balance between the 3 phases and confirms symmetry or reveals deviation.



**RESISTANCE TEST**

Performs a phase-to-phase survey of the resistance of the winding. Unbalances are typically due to connection issues.



**INSULATION TEST (Insulation to Ground)**

Performs a SAFETY check of the condition of the insulation to ground of the electrified components of the motor.

*Before conducting an insulation to ground test, all equipment in the tested circuit must be able to handle the load (i.e. VFDs, relays, controllers, etc...)*



**SET**

Opens the SETUP menu to manage stored test data, set date and time options, or take manual tests/measurements.



**PWR OFF**

Turns the device off. The instrument will power off automatically after 5 minutes of inactivity.

**NOTE:** In order to save a complete set of test data, the tests must be done in the following order: RES, INS, Motor Genie Test.

*If tests are not conducted in order, the Results Screen after the Motor Genie Test may display NoR (No Results).*



+1 860 399-4222



support@alltestpro.com  
www.alltestpro.com



20 Research Parkway, Suite G  
Old Saybrook, CT 06475 USA



**Steps for Comprehensively Testing a New Motor from Junction Box or at the Motor Control Center**

1 INS Test	2 RES Test	3 Motor Genie Test	4 Results & Saving Data
<p>Select <b>INS</b> icon</p> <ul style="list-style-type: none"> <li>• Press OK</li> </ul> <p>Connect <b>Blue</b> to phase 2 and <b>Yellow</b> to ground</p> <ul style="list-style-type: none"> <li>• Hold the <b>TEST</b> key until value stabilizes (&gt;5G max)</li> </ul> <p>Results will be saved in temporary memory.</p>	<p>Select <b>RES</b> icon</p> <ul style="list-style-type: none"> <li>• Press OK</li> </ul> <p>Connect <b>Black</b> to phase 1, <b>Blue</b> to phase 2 and <b>Red</b> to Phase 3 (yellow ground not required)</p> <ul style="list-style-type: none"> <li>• Press OK</li> </ul> <p>Resistance results 'Warn' and 'Bad' typically indicate a connection issue.</p> <ul style="list-style-type: none"> <li>• Press OK</li> </ul> <p>Results will be saved in temporary memory.</p>	<p>Select '<b>Motor</b>' icon</p> <ul style="list-style-type: none"> <li>• Press OK</li> </ul> <p>Connect <b>Black</b> to phase 1, <b>Blue</b> to phase 2 and <b>Red</b> to Phase 3 (yellow ground not required)</p> <ul style="list-style-type: none"> <li>• Press OK</li> </ul> <p>100Hz is default</p> <p>Save Phase T1-T2 results by pressing '<b>Test</b>' key twice slowly</p> <ul style="list-style-type: none"> <li>• Press F2</li> </ul> <p>Save in Phase T1-T3 results by pressing '<b>Test</b>' key slowly</p> <ul style="list-style-type: none"> <li>• Press F2</li> </ul> <p>Save in Phase T2-T3 results by pressing '<b>Test</b>' key twice slowly</p> <ul style="list-style-type: none"> <li>• Press OK</li> </ul> <p>Results Screen will appear</p>	<p>To Save Data:</p> <p>Select '<b>SAVE</b>'</p> <ul style="list-style-type: none"> <li>• Press OK</li> </ul> <p>Select 1 of 7 save slots. If existing results are saved, a date/time stamp will appear at the bottom of the screen. If the bottom appears blank, there are no existing results in that save slot.</p> <p>*The INS, RES, and Motor Genie tests must be conducted in this order to successfully save all test data.</p>

NOTE: Wait for audible 'beep' sound to confirm successful button press.



+1.860.399-4222



support@alltestpro.com  
www.alltestpro.com



20 Research Parkway, Suite G  
Old Saybrook, CT 06475 USA

## **1. Introduction**

Dear Customer,

Thank you for your purchase of the new, patented **MOTOR GENIE MCA™** (MG MCA™) motor circuit analyzer from ALL-TEST Pro, LLC ® (ATP).

The MOTOR GENIE MCA™ has been developed to provide simple and accurate test methods for troubleshooting faults, commissioning new and rebuilt machines, and verifying quality assurance in electric motors.

The MG MCA™ specializes in the immediate detection of winding shorts, insulation to ground faults, cable faults, and coil issues on low voltage (<1000V) 3 phase AC induction motors. The MG MCA measures resistance and impedance at different frequencies, as well as phase angle and Current/Frequency response.

The MG MCA™ can be used as a stand-alone unit or with the accompanying Motor Genie iPhone® / Android® app to assist with further analysis and reporting.

Please stay safe by adhering to all safety protocols when using this instrument.

Thank you again for choosing ALL-TEST Pro for your motor diagnostic needs!

Sincerely,

**The ALL-TEST Pro Team**

## 2. Safety Warnings and Precautions

The Device Under Test (DUT) must be fully deenergized before the MOTOR GENIE MCA™ instrument is connected for any test.

Improper application of this instrument on live circuits is a danger to the user and will result in the destruction of the testing circuit, requiring instrument replacement.

**NOTE:** Do not touch test leads during on-going tests.

Symbols used on the instrument:	
	Important information; see user manual !
	WARNING: risk of electric shock !
	Equipment complies with EU regulations and directives regarding safety and electromagnetic compatibility
	Do not dispose of this product as unsorted municipal waste
	Lead free equipment, complies with EU RoHS directive regarding restriction of hazardous substances



### Important Information

Safety warnings and precautions must be read and understood before using the instrument. All safety warnings and precautions must be adhered to during instrument use.

Follow OSHA (or country equivalent) and your company's safety rules and regulations for deenergized testing methods, including wearing appropriate Personal Protective Equipment (PPE).

Improper or unsafe operation of the ALL-TEST PRO MG MCA™ is the sole responsibility of the user.

Do not open the main body of the instrument. Opening the instrument body will void the warranty. There are NO serviceable parts inside.

Electrostatic charges may damage surface mount electronics. Additional battery packs can be purchased from ALL-TEST Pro, but care must be exercised during battery installation, as electrostatic charges may damage surface mount electronics.

**NOTE:** Only approved original equipment (OEM) battery packs and chargers should be used. The use of non-OEM batteries and chargers may damage the instrument and will void your warranty.



### Risk of Electric Shock

The ALL-TEST PRO MG MCA™ is only to be used on deenergized motor equipment. Connecting the instrument to live voltage will damage the instrument and void the warranty. Always verify that the motor circuit is deenergized before connecting the instrument to any electrical equipment under test and follow lock out tag procedures.

Ensure that all power has been removed from the circuit being tested, including static power stored in capacitors. Discharge all capacitors located in the circuits being tested. In addition, disconnect any power factor correction capacitor or lightning arrestor that is in the test circuit to avoid erroneous test results.

The ALL-TEST PRO MG MCA™ sends out a series of low voltage, high frequency AC and DC test signals to the motor to exercise the winding insulation system. These voltages are not harmful to the technician or most electronic equipment (variable frequency drives, encoders, soft starters, etc.). However, personnel must observe appropriate safety procedures.

### Additional Considerations

- 1) Verify with your equipment supplier if any sensitive electronic components should be disconnected before performing the Insulation Resistance to Ground Test (INS).
- 2) Test leads, including crocodile clips, must be in good condition to conduct each test as accurately as possible. Test leads should be clean and have no broken or cracked insulation. Test points should also be clean and securely connected. Only the supplied (shielded) test leads and clips should be used. The use of additional cable(s) between the test clips and motor terminals can introduce EMI hum and/or other interference that can result in erratic readings. In addition, it should be noted that longer cable lengths can also influence the collected data.
- 3) Environmental considerations for shipping and disposal: Follow government guidelines when shipping or disposal of instruments. Instrument contains lithium rechargeable ion batteries.





## **3. Standard Equipment & Warranty**

### **3.1 Equipment Contents**

- ✓ **ALL-TEST PRO MG MCA™** with back-lit graphic LCD screen (128x64 pixel) and back-lit keypad
- ✓ **3x Test leads**, 1-meter, with custom Kelvin Clips
- ✓ **1x Test lead**, 1-meter, with 4mm safety plug and Dolphin clip
- ✓ **DC 9V 1.7A Power Supply**
- ✓ **User Manual** on USB



*Please download the MOTOR GENIE APP available for free for IOS/Android.*

### **3.2 Warranty**

One-year limited warranty from date of purchase included. See ALL-TEST Pro Terms and Conditions for details.

### **3.3 Accessories**

The following accessories are currently available for purchase at [alltestpro.com](http://alltestpro.com) or your equipment supplier:

1. **Clear Face Soft Case** (Carrying pouch for instrument & test leads) - Part# 40077
2. **Battery pack** - Part# 40028
3. **DC charger** - Part# 40051
4. **Strap Wrench** - Part# 40069
5. **3-meter Test Leads Kit** - Part# 40082

### **3.4 Training & Support**

Training Courses are available virtually, privately at your facility, or held publicly at various locations throughout the world. Contact the ALL-TEST Pro training department at [sales@alltestpro.com](mailto:sales@alltestpro.com) or your distributor for more information.

## 4. Instrument Features

### 4.1 Exterior

#### 4.1.1 Front Panel



1. Graphical LCD display 128x64, white LED backlight
2. Charging status indicator LED, bicolor Red / Green
3. Active status indicator LED YELLOW
4. Keypad area sealed tactile switches. Press ↓ down ↑ up → right ← left & ok (enter, return, proceed)



#### 4.1.2 Connection Ports

1. Phase 1 Test Lead input/output port **BLACK**
2. Phase 2 Test Lead input/output port **BLUE**
3. Phase 3 Test Lead input/output port **RED**
4. 500V & 1000V output test port **YELLOW**
5. USB port (Type B) for PC communication
6. Charger input DC 9V, 1.7A (center pin + polarity)

## 4.2 Batteries and Charger

The built-in rechargeable Lithium (Li-ION) batteries support eight hours or more of normal testing. 2.5 hours of charging is typically necessary to fully charge the battery. Do not charge when ambient temperature is below or above range as listed in the specifications (see page 11 for more details).



**CAUTION:** Only use the supplied power supply for charging. Using the wrong charger could damage your instrument.

Charging status is indicated by bicolor LED to the left of the keyboard:

**Red** = Battery conditioning and charging  
**Green** = Charge complete (Done)

**Red + Green** = Sleep mode or temperature fault  
**No Light** = Device not sensing charger connection

Battery charge is indicated on the main menu as one of four possible levels or will show the word LOW.

When the charger is plugged into line power, the charging circuit automatically resumes charging when the battery voltage falls below the predetermined threshold.

**NOTE:** The Li-Ion batteries have built in over-discharge protection circuits, activated if the cell voltage falls below a threshold that will disconnect the cell resulting in no power! The solution is to recharge the batteries.

**NOTE:** Do NOT conduct any testing while the unit is charging.

## 4.3 Test Frequency

MOTOR GENIE MCA™ applies low voltage, sinusoidal signals to perform Z, I/F, and  $\psi$  measurements.

The display indicates the frequency selection for the test.

**NOTE:** Default Test Frequency is set as 200Hz.

### Z and $\psi$ Test Frequency Options

25Hz, 50 Hz, 100Hz, 200Hz, 400Hz, 800Hz.

### I/F Test Frequency Options

25Hz/50Hz, 50Hz/100Hz, 100Hz/200Hz, 200Hz/400Hz, and 400Hz/800Hz.

	25Hz	50Hz	100Hz	200Hz	400Hz	800Hz
Z	YES	YES	YES	YES	YES	YES
Ψ	YES	YES	YES	YES	YES	YES
I/F	25Hz/50Hz	50Hz/100Hz	100Hz/200Hz	200Hz/400Hz	400Hz/800Hz	Switch to 400Hz



**NOTE:** It is possible that the above guidelines of identifying developing winding faults can be provide a developing fault if the wrong test frequency is used. However, if a “winding fault” is developing it will test bad at all frequencies. So, if either the  $\psi$  or I/F, indicate a developing fault at a single frequency retest at another frequency. If the winding tests good at any frequency, then the winding insulation is in good condition. Generally, a good winding can provide a “bad” result if the incorrect frequency is used, but a true fault will indicate bad at all frequencies.

**NOTE:** Induction motors are electrically like transformers with a rotating secondary. The stator coils represent the primary of the transformer, and the rotor bars represent the secondary. Even with fault free squirrel cage induction motors it is possible to have an unequal allocation of rotor bars residing under each of the individual three phase coils while the rotor is in a static position. This creates an inductance (L) unbalance caused by the unequal number of rotor bars currently residing under each of the phases. This situation will create an impedance (Z) unbalance due to rotor position. **In such an instance, you will need to Perform the Rotor Compensated test.**

### 4.4 Temporary Memory

Temporary Memory collects and holds the latest measurement data during the test process. You can review and save the Temporary Memory Test Data in nonvolatile memory at the end of the MOTOR GENIE test.

#### Temporary Test Memory Structure:

<b>Resistance Test Data</b>		T1-T2 Resistance	T1-T3 Resistance	T2-T3 Resistance
<b>Insulation Test Data</b>		Insulation Resistance, Test Voltage 500V/1000V		
<b>MOTOR GENIE Real Time Test Data</b>		T1-T2 Impedance	T1-T3 Impedance	T2-T3 Impedance
		T1-T2 I/F value	T1-T2 I/F value	T1-T2 I/F value
		T1-T2 Phase Angle	T1-T3 Phase Angle	T2-T3 Phase Angle
		T1-T2 Max. Impedance (Phase Balance)	T1-T3 Max. Impedance (Phase Balance)	T2-T3 Max. Impedance (Phase Balance)
		Test Frequency		

## 4.5 Specifications

**Test Frequencies:** 50, 100, 200, 400, 800 Hz

**Motor Genie Test:** Repeatability  $\pm 1\%$ , (of measured data and calculated deviations)

**Resistance:**

True 4-wire Kelvin measurement.

Compensation for thermoelectric offset voltages.

Measurement range: 0.1 m $\Omega$  – 999  $\Omega$

Absolute accuracy:

- 0.1m $\Omega$  – 9.99 m $\Omega$   $\pm 1\%$   $\pm$  one digit, Max Resolution: 0.01 m $\Omega$
- 10.0 m $\Omega$  – 99.9 m $\Omega$   $\pm 1\%$   $\pm$  one digit, Max Resolution: 0.1 m $\Omega$
- 100  $\Omega$  - 500  $\Omega$   $\pm 1.5\%$ ,  $\pm$  one digit.
- 501  $\Omega$  - 999  $\Omega$   $\pm 2.5\%$ ,  $\pm$  one digit.

Relative Accuracy Phase to Phase  $\pm 0.1\%$   $\pm$  one digit.

**Screen:** Graphic LCD, monochrome 128 x 64 pixels (3.1) Viewing Area – 69mm x 36.5mm, white LED backlight.

**Temperature range storage:** -20 °C to +60 °C (-4 °F to +140 °F)

**Temperature range operating:** -10 °C to +50 °C (+14 °F to +122 °F)

**Humidity:** 0-80% relative humidity, non-condensing

**Safety:** According to IEC 61010-1 Ed. 3.0

**CE Approvals:**

- **EMC:** Emission: EN61000-6-4
- **Immunity:** EN61000-6-2, EN61000-4-2, EN61000-4-3

**Calibration Certificate:** Optional (contact nearest distributor for more information)

**Batteries:** 2 x Li-ION cells with  $\geq 2100$  mAh capacity.

UL 1642, UN38.3 Certified.

**Enclosure Size:** 126 x 218 x 51 mm (5 x 8.6 x 2) (W x L x H) (basic enclosure size without minor protrusions)

Material - Polycarbonate, UL94-V2

**Instrument Specifications:** Size: 126 x 218 x 51 mm (5 x 8.6 x 2) (W x L x H) (basic enclosure size without minor protrusions) Weight: 0.7 kg (1.5 lb.)

**Shipping Specifications:** Gross Size: 45.7x40.6x15.2 cm (18x16x6) (WxLxH) Gross Weight: 5.0 kg (11 lb.)

**Accessories Included:**

- 3x Test Leads with Kelvin Clips and push-pull connectors
- 1x Test Lead with 4mm safety plug and MC Dolphin clip.
- Charging adapter, Universal input type 85-260VAC, output 9VDC @ 1.7A.

## 5. Operation Instructions

### 5.1 Basic Functions

#### Key Functions

**NOTE:** Instrument keys may have additional functionalities in certain modes.

- (1) **MENU / UP Arrow**  
Return to Main Menu from different modes  
Moving UP selection field on vertical menu
- (2) **F1 / ON / Left Arrow**  
Power ON (Power OFF hold for 10 seconds)  
Moving Left selection on horizontal menu
- (3) **TEST / Down Arrow**  
Test activation in different modes  
Moving Down selection field on vertical menu
- (4) **OK**  
Activate Selected Item  
Return from numeric test results view window
- (5) **F2 / Right Arrow**  
Moving Right selection on horizontal menu

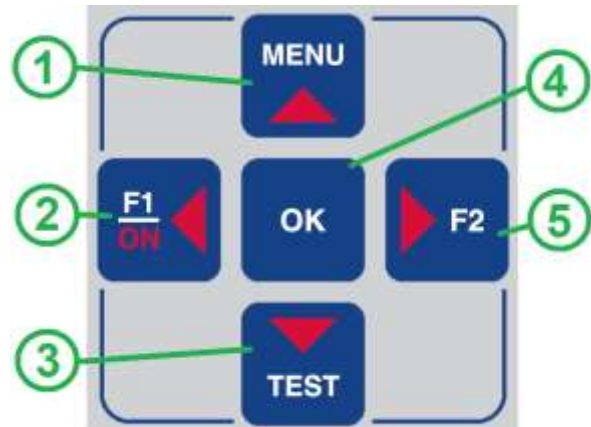

#### Turning the Instrument ON

Press the  key to power ON the instrument. The display will show the warning screen reminding the user to disconnect (device under test) DUT from power before connecting the test leads to the DUT.

Press  to proceed to main menu screen (the unit will automatically proceed from the Warning Screen to main menu after 60 seconds).

### Turning the Instrument OFF

There are 3 ways how to turn the instrument OFF: *Normal*, *Automatic*, and *Hardware Off*.

#### Normal

Use **F2** or **F1 ON** key to select (highlight) the icon PWR OFF, then press **OK**.

#### Automatic

The instrument will automatically turn OFF after 5 minutes of inactivity. The instrument will emit an audible signal (beeping tone) and lower the screen brightness 30 seconds before the automatic Power OFF occurs.

#### Hardware Off

Push and hold **F1 ON** **OK** for 10 seconds. This will turn the internal power OFF even if the firmware locked and the unit is not responsive.

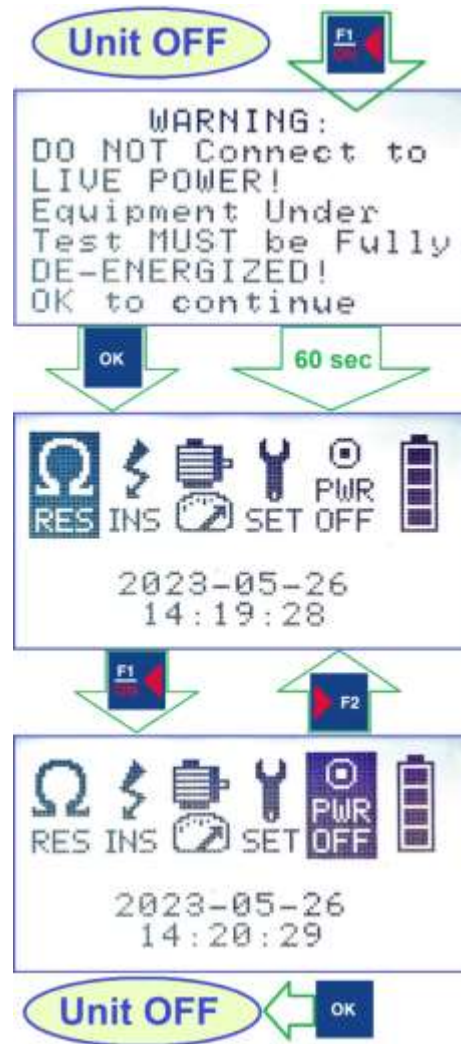

## 5.2 Main Menu

The **MAIN MENU** screen has three sections:

(1) Function Selection Area

(2) Date and Time display in YYYY-MM-DD / HH:MM:SS format

(3) Battery Charge Status Indicator will show one out of four battery charge levels and LOW.



### FUNCTION SELECTION AREA

Select specific function using **F1** **ON** **F2** keys. Press **OK** to activate one of the following functions:



#### RES $\Omega$ : Resistance test

Automatically performs three phase Resistance measurement and calculates resistance balance. Used to determine phase resistance symmetry, cabling, and motor connection quality.



#### INS: Insulation Resistance Test

High voltage (500V/1000V) ground wall insulation safety test. Used to determine the motor and/or connection cable weakest point for electrical safety.



#### MOTOR GENIE Test

Semi-automatic Real Time Measurement test which includes Impedance, I/F (current frequency response), Voltage to Current Phase Angle, and Phase Balance based on comparing maximum Impedance for each phase. Used to determine the condition of the motor winding insulation.



#### SET: Setup

Provides access to:

1) View test data stored in memory, 2) Set date and time, 3) Perform Manual Measurements, 4) Start the Calibration process



#### PWR OFF

Turns the instrument power off.



## 5.3 Testing Functions

### 5.3.1 Resistance Test



Select the resistance icon from main menu press **OK** button - instrument will display the test leads connection information. Follow the onscreen instructions to connect the test leads. and press **OK** button to start the measurement process. The instrument automatically switches phases as it conducts the measurement.

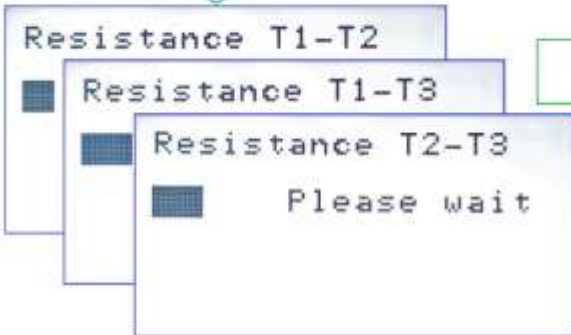
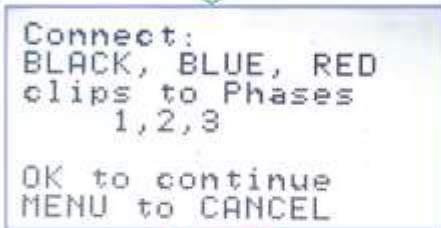

#### Resistance Result Screen



Resistance Deviation (Unbalance) from average in %

Resistance Status OK / WARN / BAD

Upon test completion, the instrument displays the result screen. The results screen will show resistance in Ohms for each phase and the resistance deviation in percent. It will also display the resistance balance status as OK, WARN, or BAD. The Resistance Test Values stored in **Temporary Test Memory** and can be later saved in the Nonvolatile Test Memory after completing the **MOTOR GENIE Test**

Press **MENU** or **OK** to return to the **MAIN MENU**.

**NOTE:** In case of a connection problem, the unit will start beeping and display "No Connection Tx-x / MENU to EXIT / Check! (OK to Skip)". Readjust the test leads and the tool will continue testing as soon as the connection is restored.

### 5.3.2 Insulation Test



Insulation Resistance: 0MΩ – 5GΩ @1000V/@500V



**WARNING: Risk of electric shock!**  
 Pressing the TEST key will output the selected test voltage of 500V or 1000V to the yellow output port and illuminate orange status LED.

1. Follow the onscreen instructions to connect the correct test leads.

**Note:** Connect the Yellow ground test lead to a bare, **unpainted** motor bolt or any other non-insulated portion of the motor frame.

2. Select the proper test voltage 500V or 1000V using **F2** key.
3. To conduct the test, **press and hold** the **TEST** button until the insulation value (IN) on the instrument stabilizes. The Insulation value shall remain constant for 5-20 seconds or until >5GΩ value is displayed. The Resistance Test information can be later stored in memory after completing MOTOR GENIE Test.
4. Press **OK** to return to MAIN MENU.

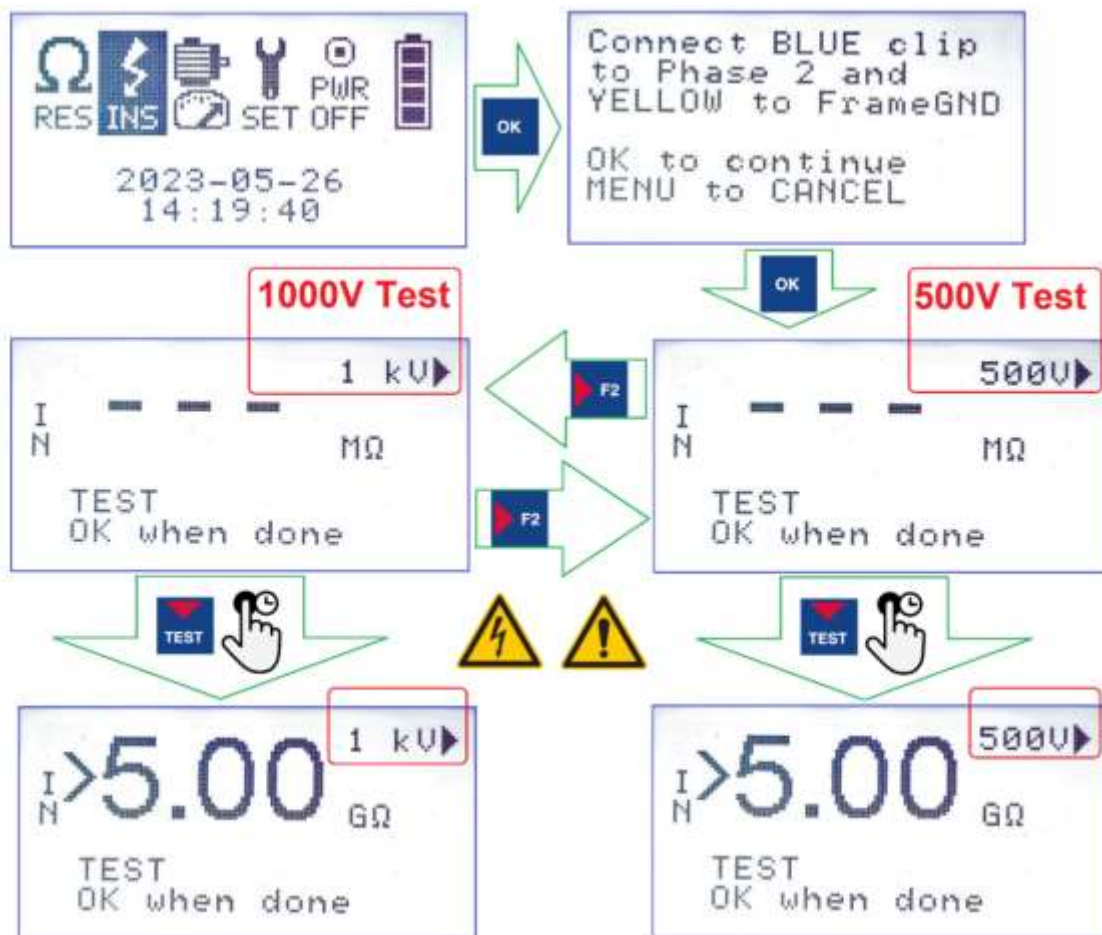

### 5.3.3 Motor Genie Test



The Motor Genie Test measures and displays a real time value of **Impedance (Z)**, or **Current Frequency Response (I/F)**, or **Phase Angle ( $\psi$ )** for each of three phases under the operator control.

#### MOTOR GENIE TEST Real Time Measurement Display Zones

##### ① Connected Phase

Displays the pair of test leads currently running the measurement.

Possible combinations are: **T1-T2 (Black & Blue test leads)**, **T1-T3 (Black & Red test leads)**, **T2-T3 (Blue & Red test leads)**.

Motor Genie Test starts the measurement with T1-T2 test leads set. To change the connected test leads

pair press the  key.

##### ② Measurement Value Display

Displays the real time value and the measurement type:

**(Z) Impedance** (Ohms)

**(I/F) Current Frequency Response** (%)

**( $\psi$ ) Phase Angle** (angular degrees)

Measurements can be accessed by pressing the  key.

##### ③ Test Frequency

200Hz is a default frequency.

Press the  key to sequentially change the test frequency to: 400Hz, 800Hz, 25Hz, 50Hz, 100Hz and back to 200Hz.

##### ④ MaxZ (only available for the Impedance (Z) measurement mode)

Displays the maximum **Impedance** value for active **Connected Phase**.



If needed, the **MaxZ** value can be reset by  key.



## ⑤ Measurement Type

Pressing the  key sequentially changes the measurement type from (Z) to (I/F), from (I/F) to ( $\psi$ ), and from ( $\psi$ ) back to (Z).

**NOTE:** The current displayed **Measurement Value** will be stored in the **Temporary Test**

**Memory** at the moment of pressing ,  to change the measurement or the  to finish the test, and later shown on the result page. The test result can be saved in non-volatile test memory.

**NOTE:** Repetitive beeping and “ - - - ” in the Measurement value zone indicates missing connection.

## 5.4 Setup Menu



Select required command from the **Setup Mode Menu** list using   keys then press



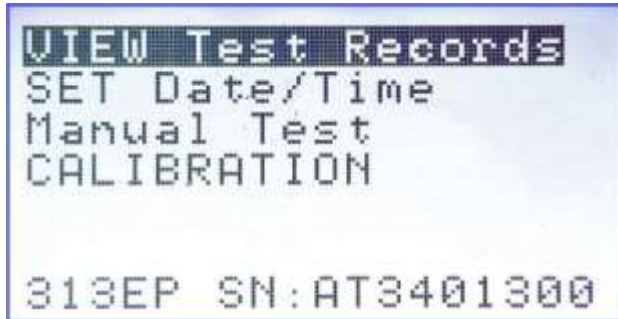

*Scrolling line information from picture:*  
Ver. MG230313EP SN:AT3401300

### VIEW Test Records

Recall and review Tests Stored in the data memory.

### SET Date/Time

Set/correct the real time clock date and time.

### Manual Test

Run one of the Measurements (**R,  $\psi$ , I/F, Z**) using one connection( **32, 21** or **13** ) corresponding to (**T2-T3, T1-T2, or T1-T3**) connections.

### CALIBRATION

Start the Calibration process.

### Serial Number & Firmware Version

The information line at the bottom of the screen shows the currently installed firmware revision and the unit serial number. The information line will scroll left to right providing the Firmware revision after the characters [**Ver.**] and the serial number after the characters [**SN:**]. The serial number of the device can also be located on the nameplate located on the backside of the instrument.

### 5.4.1 View Test Records

(Main Menu > SET > VIEW Test Records)





Select one of seven memories to view the test data using



**NOTE:** The lower part of the display screen shows the Date and Time for the selected stored test.

**DATE format:** YYYY-MM-DD

Review the OK / WARN / BAD status from the result screen. Select one of the measurements from the result screen list



using  &  keys then press  to review the specific measurement value.



The test data can be entered into the Condition Calculator application and stored as the Test Data Report.

### 5.4.2 Set Date/Time

(Main Menu > SET > SET Date/Time)



Move highlighted selection using  &  keys.

Use the  &  keys to change a highlighted value.

Press  to store the change and start the clock.

**Date format:** YYYY-MM-DD    **Time format:** HH:MM:SS



### 5.4.3 Manual Test Operation

(Main Menu > SET > Manual Test)

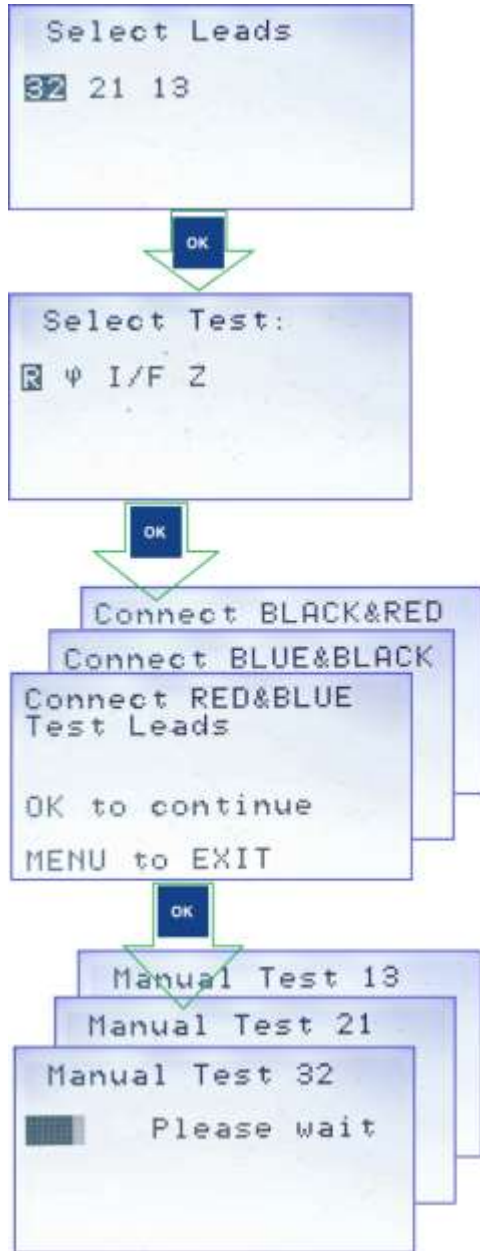

The Manual test performs individual Measurements of **R,  $\psi$ , I/F, Z** using just two test leads.

1. **Select Leads.** Select which test leads are being used for the test moving highlighted selection using **F2** & **F1/ON** keys then press **OK** to continue.

a. **Select Test.** Select the test to be performed.

**R** – Resistance measurement.

**$\psi$**  - Voltage to Current Phase Angle.

**I/F** - Current Frequency Response (the AC current change at double frequency in percent)

**Z** – Impedance in Ohms.

Move highlighted selection using **F2** & **F1/ON** keys then press **OK** to continue.

The screen displays the test leads to be used to perform the test according to previous selection. Connect selected test leads.

**32** => **RED & BLUE** test leads (T2-T3)

**21** => **BLUE & BLACK** test leads (T1-T2)

**13** => **BLACK & RED** test leads (T1-T3)

Press **OK** to continue.

The screen displays “Please Wait” and a scroll bar while the manual test measurement is being performed. The instrument automatically displays the result screen for the selected measurement when the test is complete.

**(R) Resistance**

Manual measurement result screen displays the resistance value in Ohms or milliohms. This value will also be stored in the Temporary Test Memory for the corresponding phase.

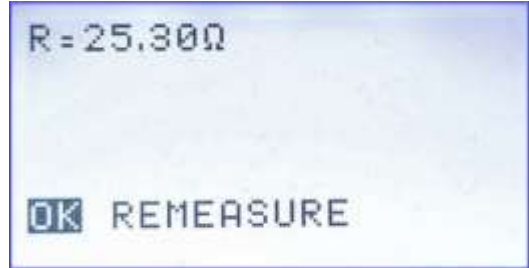

**(ψ) Phase Angle**

manual measurement result screen displays four measurements done at 50Hz, 100Hz, 200Hz, and 400Hz frequencies.

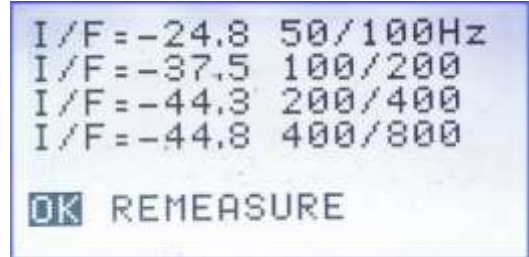

**(I/F)Current Frequency Response**

result screen displays four measurements which are done at each frequency pair: 50/100Hz, 100/200Hz, 200/400Hz, and 400/800Hz.

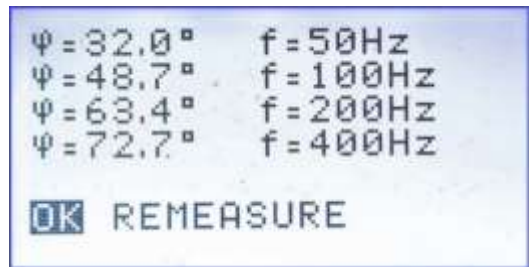

**(Z) Impedance**

at selected frequency in Ohms. Impedance measurement is done at four different frequencies 50Hz, 100Hz, 200Hz, and 400Hz. The result screen displays values at each frequency.



**5.4.4 Calibration**

(Main Menu > SET > CALIBRATION)

**CALIBRATION mode is ONLY used to calibrate this instrument.**

See the Calibration Manual (available at <https://motorgenie.com>) to proceed with the calibration process.



Press  to cancel the calibration and return to Main Menu.

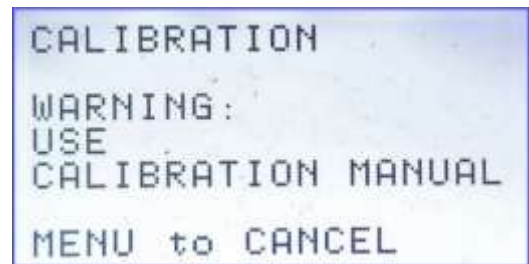



## 5.5 Measurement Screen Controls

At any point during testing the **Measurement type**, **Connected Phase** or **Test Frequency** can be changed.

**To change the Measurement type** Press **TEST** key to switch between Impedance (**Z**), Current Frequency Response (**I/F**), and Phase Angle (**ψ**) measurement.

**To change Connected Phase** - press **F2** key to switch between three phases test leads **T1-T2**, **T1-T3**, **T2-T3**.

**Test Frequency change** - press **MENU** key to scroll between 25Hz, 50Hz, 100Hz, 200Hz, 400Hz, or 800Hz test frequency.

Press **OK** at any point of time to finish the test and switch to the Result Screen.

**NOTE:** The 800Hz frequency is not available for the I/F measurement and will be automatically changed to 400Hz.

**NOTE:** Changing the test Frequency will clear all previously taken data from the memory buffer.

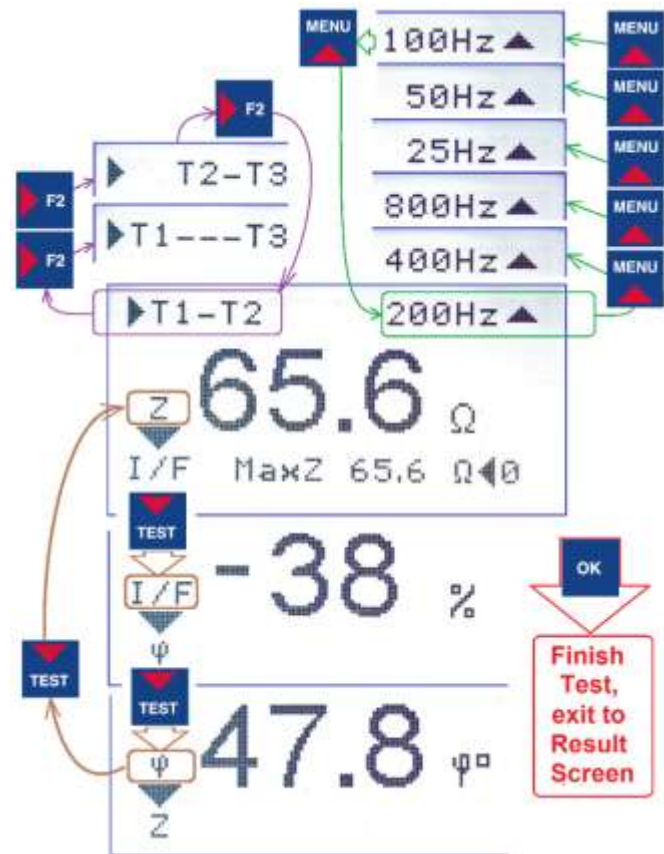

**Impedance Maximum (MaxZ)** value automatically collected in Impedance measurement mode. It will be later used in **Phase Balance** calculation and analysis.

## 5.6 Results Screen

The results screen evaluates the values of the measured variables and compares them to predetermined guidelines and provides results in 3 alarm levels (**OK/WARN/BAD**). **NoR** indicates that the measurement was not taken. See analysis section for alarm guidelines.

**R – Resistance data** shows previously measured Resistance and calculated deviation for each phase in percent.

**Z – Impedance** data from current test for each phase in Ohms and calculated deviation for each phase in percent and Test Frequency.

**I/F – Current Frequency** response in percent for each phase and calculated difference between the phases and a set of Frequencies used for the I/F test.

**PB – Phase Balance** calculated as a difference between **MaxZ** Impedance for each phase (use for the **Rotor Compensated test only**).

**Phase Angle** in angular degrees for each phase and calculated difference between the phases

**Insulation** – results of previously taken insulation test

### Saving the Test Data

Test results can be stored in nonvolatile data memory for future review.

Select one of seven Memory cells available at **Motor Genie**.

Press **OK** to save the test data. Overwrite the memory to save a new test record in the previously used slot.

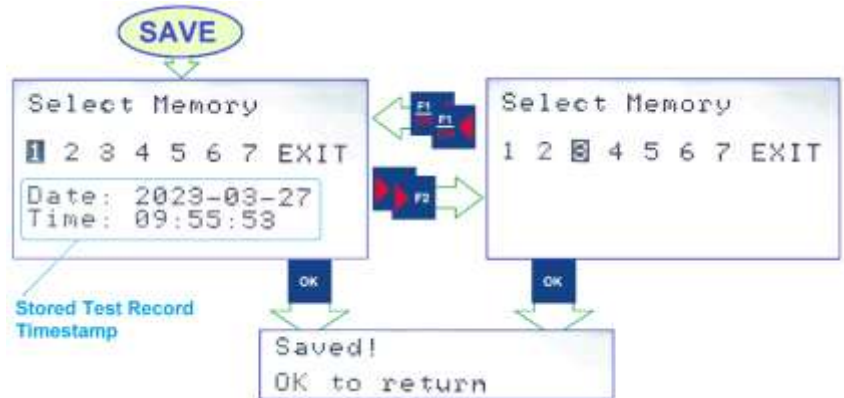

### Resetting the Maximum Impedance (MaxZ)

If necessary to remeasure the **MaxZ** it can be reset by pressing the **F1 ON** key.

After 1 second, the **MaxZ** value will return to current Impedance reading. Repeat the full-turn shaft rotation after the reset.

*To obtain correct maximum Impedance MaxZ reading slowly rotate the motor shaft for one full turn.*



## 6. Good, Warn, Bad Analysis Measurement Guide

The **MOTOR TEST Result Screen** displays the values of the measured variables and compares them to predetermined guidelines and provides results in 3 alarm levels (**OK/WARN/BAD or NoR**).

**GOOD** – measured values indicate proper functionality and quality for future continued use.

**WARN** – measured values indicate lower quality readings that indicate the future continued use could be in jeopardy. Warn indication can indicate a developing issue in the measured parameter that may affect the longevity of the motor and or needs remediation to remedy the issue before motor is run to failure.



**BAD** – The measured value is BAD. This means the test performed failed and this measured variable has been deemed as FAIL by the instrument or APP or software.

**NoR** – no measurement done, or condition value is not calculated by the instrument.  
Retake the test.







Value Type	Condition Calculations Method	GOOD	WARN	BAD
<b>Resistance</b>	Rdev - Deviation from Average in percent (%) for each of 3 phases. Alarm based on maximum (worst) value.	$Rdev < 3\%$	$3\% \leq Rdev < 5\%$	$5\% < Rdev$
<b>Impedance</b>	Zdev - Deviation from Average in percent (%) for each of 3 phases. Alarm based on maximum (worst) deviation.	$Zdev < 3\%$	$3\% \leq Zdev$	<i>na</i>
<b>I/F</b>	Delta ( $\delta$ ) absolute difference between phase pairs. Alarm based on maximum (worst) value.	$\delta < 1.3\%$	$1.3\% \leq \delta < 2\%$	$2\% < \delta$
<b>Phase Angle</b>	Angle ( $\psi$ ) Absolute difference between phase pairs. Alarm based on maximum (worst) value.	$\psi < 1.3\%$	$1.3\% \leq \psi < 2\%$	$2\% < \psi$
<b>Phase Balance (Zmax balance)</b>	<b>For Rotor Compensated test only.</b> PB calculated out of Zmax (maximum captured Impedance value) as an absolute difference from the smallest of 3 phases Zmax. Displayed in percent (%). Alarm based on maximum (worst) value.	$PB < 5\%$	$5\% \leq PB < 10\%$	$10\% < PB$
<b>Insulation</b>	Alarm based on the insulation resistance in Mega Ohms.	$20M\Omega \leq IR$	$5M\Omega \leq IR < 20M\Omega$	$IR < 5M\Omega$

## 7. Collecting the Complete Set of Motor Test Data

- 1<sup>st</sup> Run the Resistance Test to collect the phase Resistance Values.
- 2<sup>nd</sup> Perform the Insulation Test to collect the Insulation Resistance Value.
- 3<sup>rd</sup> Start the MOTOR GENIE real time test and collect all data by switching between all 3 phases (T1-T2-T3) and taking every measurement (Impedance, I/F, and Phase Angle) for each phase.

**NOTE:** During the MOTOR GENIE real time test, the value of the displayed parameter will be **saved in the memory** when you switch to a different phase , or change measurement type , or press  to continue to the result screen. **The previous memory content will be rewritten with the last value seen on the display.**

**EXAMPLE:** Scrolling through (T1-T2)  (T1-T3)  (T2-T3) will save (T1-T2) and (T1-T3) values.

The (T2-T3) will be saved when you press one of , , or . But if you use  button the unit will return to (T1-T2) phase and previously saved (T1-T2) value will be replaced with the new as soon as you press , , or .

**NOTE:** T1-T2, T2-T3, T2-T3 MaxZ value will be saved as {Tx-Tx Max. Impedance} at the same time as {Tx-Tx Impedance}.

**NOTE:** {Tx-Tx Max. Impedance} values converted to **Phase Balance** values on the result screen.

**NOTE:** Previously taken Resistance and Insulation Measurements values (on different motor) will be overwritten by performing **Resistance** and **Insulation** tests.

Angle ( $\psi$ ) for each phase (T1-T2, T1-T3, T2-T3)

## Complete data collection:

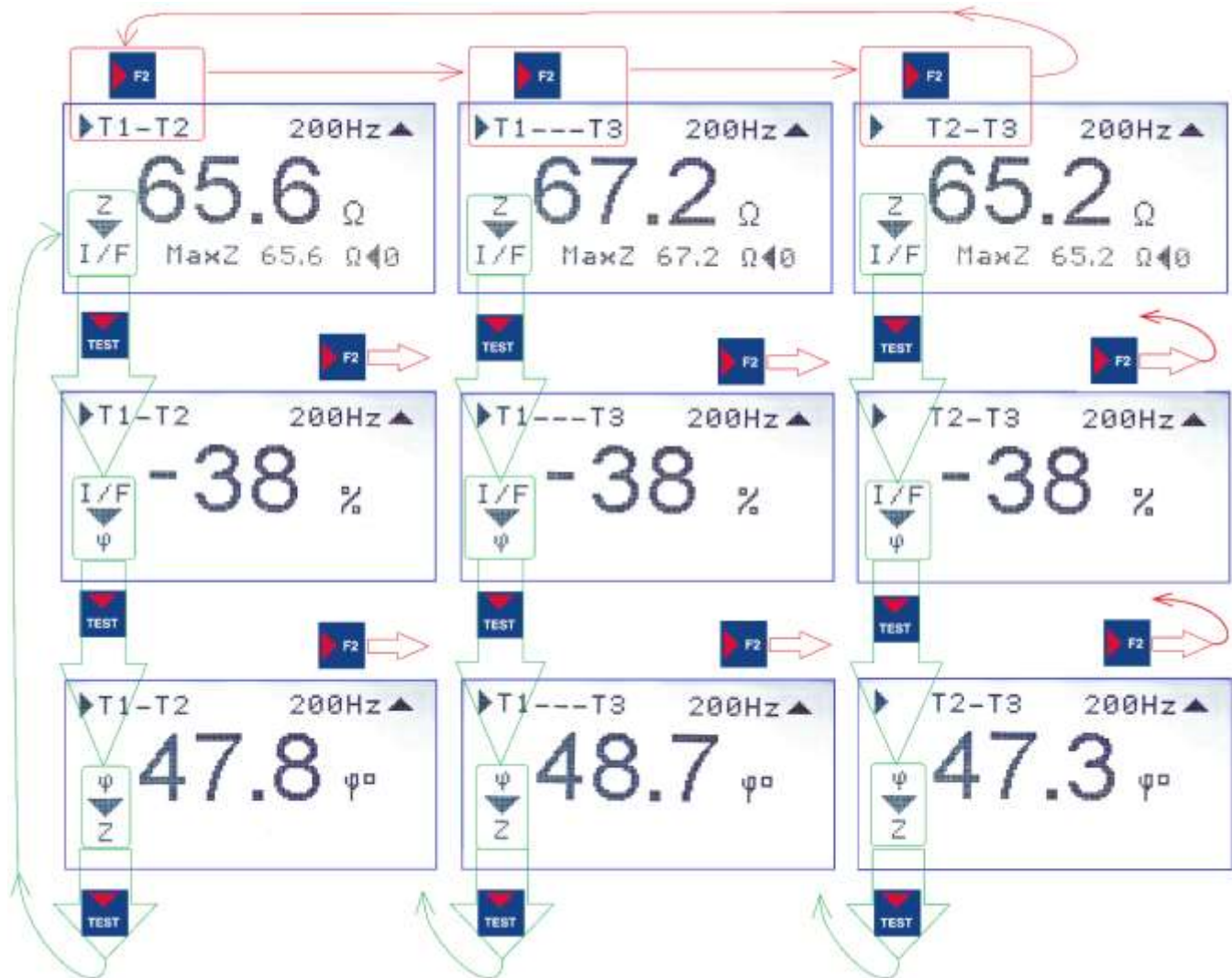

Finish the measurement process pressing **OK** any time (after all values for all 3 phases are collected). This will save the latest value to Temporary Test Memory, stops the real time measurement, and display the test result screen.

**NOTE:** Changing the test Frequency will clear all previously taken data from Temporary Test Memory and a new cycle of measurements needs to be repeated.

**NOTE:** Test Frequency 800Hz can only be used for Impedance (Z) and Voltage to Current Phase Angle ( $\psi$ ) measurements. Unit will change 800Hz to 400Hz at the Current Frequency Response (I/F) measurement mode.

## 8. Typical Motor Testing Procedures

These are the recommended tests to evaluate the condition of a typical three-phase squirrel cage motor:

1. ALL TEST PRO MCA Tools required that the **Motor MUST be Fully DEENERGIZED**. Put the **Main Switch** into the OFF position or use any other available method to disconnect the **Power** from the **Motor**.
2. Test the Motor Phase resistance directly on the motor or connecting to Wires(cable) on the Contactor. If possible, make direct resistance measurement on the motor and Cable and compare the test results to check the Cable connection quality. Refer to **RESISTANCE TEST operation** on Page 29.
3. Test the Ground Wall Insulation. Safety check is a very important test. Perform the Motor **INSULATION TEST**. Refer to **INSULATION TEST operation** at on Page 30.
4. Run the **MOTOR GENIE TEST** to check if there are any early indications of developing winding insulation faults. Refer to **MOTOR GENIE TEST operation** on Page 33.
5. **Save the motor test results** into nonvolatile memory and later transfer the test results into the Motor Genie application to generate the test report.

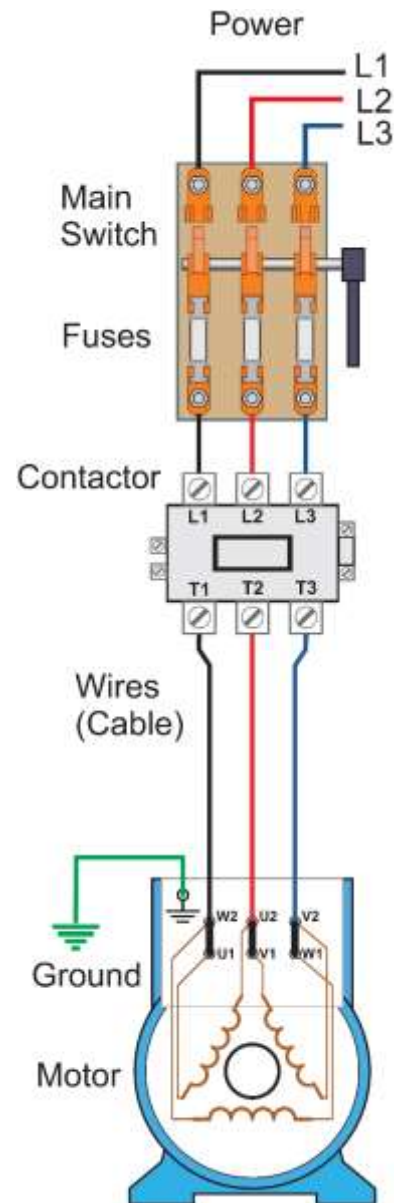



## 8.1 Resistance Test Instructions



Connect all three test leads to the motor  
 ① ② ③ and push the [OK] button.

Resistance test sequentially measures the resistance of all three phases in 0.0Ω - 999Ω range, with 0.01mΩ resolution at 0.0Ω to 9.99mΩ range. The test performs true 4-wire Kelvin measurement for accurate low resistance results, and it also includes automatic compensation for thermoelectric offset voltages.

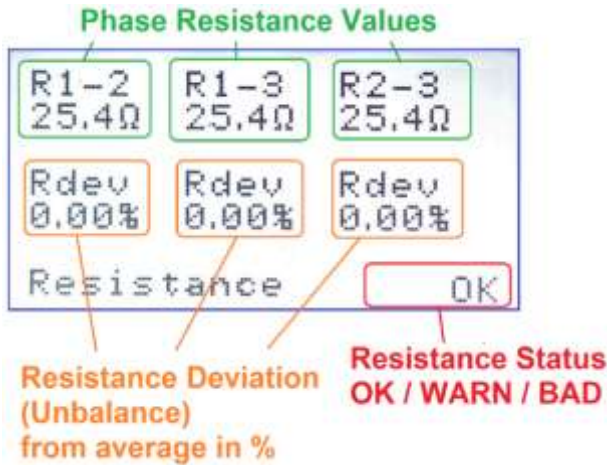

When resistance measurements are completed, the result screen displays the resistance in Ohms for each phase and the phase resistance deviation unbalance in percent calculated as the % difference from average (3 phases) resistance.

The resistance deviations of less than 3% show the good coil symmetry and a contact quality.

Increased deviations in resistance can be caused by poor, dirty, or loose connections, pitted contactors, imbalance between phases, improper turns on phases, or shorted coils.

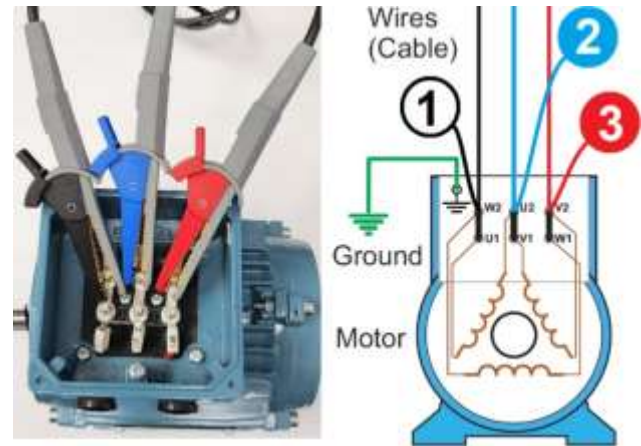

The Resistance test can be performed at different connection locations:

- Directly on the motor ① ② ③ – testing motor phase coils/connections
- From MCC (Motor Control Center) ④ ⑤ ⑥ – testing motor with cable and all intermediate connections

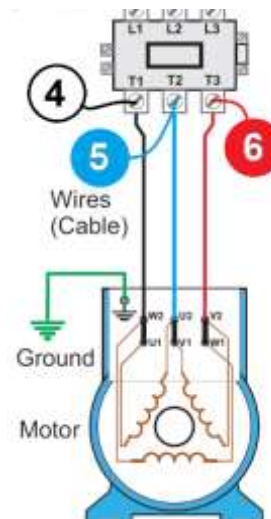

Resistance Deviation	Resistance Status	Status Definition
< 3 %	OK	Good motor (Good cable and connections)
≥ 3% < 5 %	WARN	Resistance deviation is higher than normal. That may affect the longevity of the motor causing contact overheating, energy loss, etc., and needs remediation to the issue before motor is run to failure.
≥ 5 %	BAD	Resistance deviation is too high. Check the poor, dirty, or loose connections, pitted contactors, imbalance between phases, improper turns on phases, or shorted coils.
No Reading	NoR	Resistance measurement not taken

## 8.2 Insulation Test Instructions



**WARNING: Risk of electric shock!**  
Pressing the TEST key will output the selected test voltage of 500V or 1000V on the yellow output port and illuminate orange status LED.

- 1) Select the **INSULATION TEST** icon from main menu  
press **OK** to start.
- 2) The default test voltage is set to 500V. Select the 500V or 1000V test voltage pressing **F2**.

*Guidelines for test voltages are presented in the **Test Voltages Guidelines** table below.*

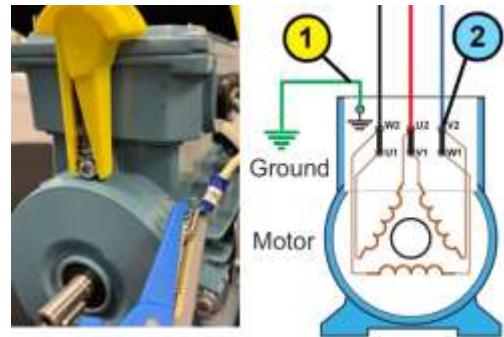

- 3) Follow onscreen instructions to connect Yellow **①** and Blue **②** test leads.
- 4) To conduct the test, **press and hold** the **TEST** button (up to 1 minute) until the insulation value (IN) on the instrument stabilizes. Insulation value shall remain constant for 5-20 seconds or **>5.00GΩ** is displayed.





**NOTE:** Connect Yellow test lead **①** to an unpainted motor bolt or any other non-insulated portion of the motor frame. If testing from the MCC then connect the yellow lead to any ground connection.



**Best electrical practices require verifying that the yellow ground lead is properly connected to ground or machine frame. To verify the proper connection:**

- Connect the yellow test lead to the motor frame or ground, then connect the blue lead to the machine frame at a different point or location.
- Press and hold the  for several seconds to complete the verification test. **The screen should display 0.0 MΩ.** If this is true, then leave the yellow test lead in place and move the blue test lead to the desired motor lead.
- **Any value larger than 0.0 MΩ** indicates one of the test leads is not connected to ground or the machine frame. Move the blue lead to another location on the machine frame and retest. If 0.0MΩ is not displayed move the yellow to another location on the machine frame. Ensure that the selected location is not painted or coated by any other insulating material.
- Continue moving the test leads one at a time until 0.0MΩ is achieved. Then leave the yellow test lead  in place and move the blue test lead  to the desired motor lead.

- 5) Release the  button. The results screen will display the measured Insulation resistance value and also display the DC test voltage (500 or 1000V) applied to the winding to perform this test. The Insulation resistance value and test voltage automatically saved in Temporary Test Memory and can be stored in memory after completing MOTOR GENIE Test
- 6) Press  to return to MAIN MENU.

**NOTE:** The INSULATION TEST only measures the ground wall insulation value for Safety purposes. This measurement doesn't provide the overall condition of the GWI (Ground Wall Insulation) system but only measures the weakest insulation point.

### Test Voltages Guidelines (IEEE 43-2013)

Motor Voltage Rating	Insulation Test Voltage
< 1000 Volts AC	500 V
1000 – 2500 V	1000V

Readings of insulation resistance are taken after the test voltage has been applied for 1 min. If these values differ from your equipment manufacturers, follow their guidelines.

**Insulation Resistance Values (IEEE 43-2013)**

Application	Pass/Fail Value
Insulation systems prior to 1970	> 1 Meg-Ohm + 1 Meg-Ohm per kV rating of motor
Random Wound motors less than 600 V	> 5 Meg-Ohms

**MG MCA defines the Ground Wall Insulation status as shown on the table below:**

Insulation Resistance	Insulation Status	Status definition and explanation
$\geq 20.0 \text{ M}\Omega$	OK	The motor and or circuit is safe to run. Note: instrument displays GΩ.
$\geq 5.00 \text{ M}\Omega < 20.0 \text{ M}\Omega$	WARN	The 600V rated Ground Wall Insulation passes the safety margin. But that may affect the longevity of the motor and or needs remediation to the issue before motor is run to failure. Follow your equipment manufacturers guidelines.
$< 5.00 \text{ M}\Omega$	BAD	The motor is not safe to use. Ground Wall Insulation must be repaired.
No Reading	NoR	No Insulation Resistance readings were taken.

## 8.3 Motor Genie Test Instructions



The **MOTOR GENIE TEST** measures and displays in real time **Impedance(Z)**, **Current Frequency Response (I/F)**, **Phase Angle ( $\psi$ )**. It is designed to provide early indications of developing the winding's insulation faults indicating OK/WAR/BAD status on the result screen.

During testing, Motor Genie MCA applies a low voltage AC sinusoidal signal at the selected frequency to the windings under test. These signals exercise the insulation surrounding the conductors-windings in the motor stator.

Coils and winding in the same condition will provide the same response to these injected signals.

The ideal three phase motor is perfectly symmetrical (equal) phase to phase, but the Conductors or Coils with degrading insulation surrounding the conductors will "not" respond the same to the injected AC signal, which will create unbalanced measurements at the Test Result Screen showing WARNING or BAD status.

To start the MOTOR GENIE TEST, connect Black, Blue, Red test leads ① ② ③ to the motor (same way as for the Resistance test) and press [OK]

MG TEST starts with measuring **Impedance(Z)** for T1-T2 test leads, at **200Hz** frequency.

**Keep the Rotor in a stationary position**, wait until the displayed value is stable for several seconds before switching to another Test Leads set, or changing the Measurement Type. Changing the rotor position between phases or measurement types will result in invalid data, the instrument does not have the capability to identify if the rotor position has been changed during testing, so it relies on the operator to ensure this doesn't occur.

If the **Measurement Value is continuously significantly fluctuating**, then the measurement might be affected by external electrical noise or motor rotor rotation.

The fluctuation of more than one digit  $\pm 1\%$  is significant. It will interfere with motor testing results

and should be considered **"invalid"**. The cause of significant fluctuation should be investigated.

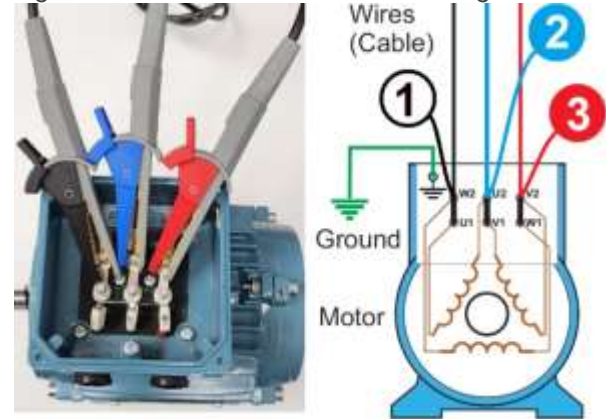

Common examples of fluctuating results include:

- Fan rotating due to damper blow by or fluid flowing through an impeller.
- Similar instance where shaft could move without power.
- The cable connected to the deenergized motor is subject to Electromagnetic interference (EMI) created by an energized cable residing near the motor under test feeder lead.

### Collect All Data for Final Analysis

Complete analysis of a winding condition requires testing all three phases of the motor with the rotor in a stationary condition. Refer to Collecting The Complete Set of Motor Data on Page 26.

### 8.3.1 Realtime Values

**(Z) Impedance** is a measure of the opposition to electrical flow. It is measured in ohms. For Direct Current (DC) systems, Impedance(Z) and Resistance(R) are the same, defined as the Voltage (V) across an element divided by the Current(I) ( $R = V/I$ ). In AC systems, the "reactance" enters the equation due to the frequency-dependent contributions of Capacitance(C) and Inductance(L) added to the Resistance(R). **Impedance** in an AC system is still measured in ohms and represented by the equation  $Z = V/I$ , but V and I are frequency-dependent, that makes the **Impedance(Z)** also frequency-dependent.

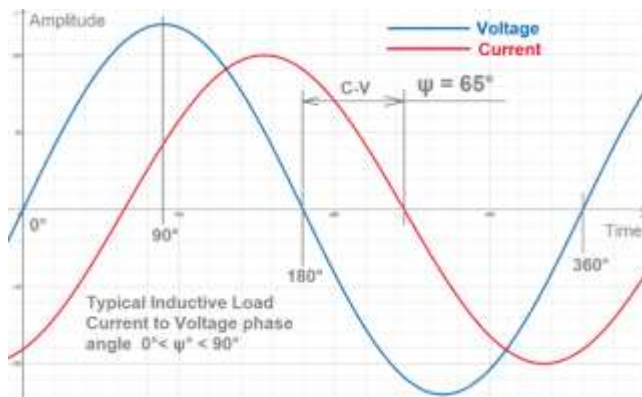

**(I/F) Current Frequency Response** compares the current change of the test signal as the frequency is doubled (example 200Hz and 400Hz). Result displayed in percent (example I/F=-44.3%). This measures the ability of the winding system to store a magnetic field or an electrical charge.

Coils and windings in the same condition, respond the same between each other at all frequencies.

However, when the insulation surrounding the conductors in the coils that make up the phase windings undergo chemical changes that indicate developing faults, this varies the Current Frequency Response on the affected winding creating an unbalance.

Unbalances of the **(I/F)** in any of the phases which are > 2% from the average provide early indication of a developing winding short.



**(ψ) Phase Angle** represents the phase shift between applied AC Voltage and Current measured in angular degrees.

An ideal inductance has a theoretical phase angle =90°. The real motor winding is mostly inductive (L) plus wire resistance (R) and a small capacitance (C). So the real Inductive Load phase angle is in  $0^\circ < \psi < 90^\circ$  range.

When the insulation surrounding the conductors in the coils making up the phase coils undergo the chemical changes that occur as the insulation degrades, very small changes in the proportional relationship between R, L, C will change and will cause the time delay between the injected voltage and the resulting current to change, the **ψ** provides very early indication of these changes.

Unbalances of the **ψ** in any of the phases which are >1° degree from the average provide early indication of a developing winding short.

### 8.4 Rotor Compensated Test Instructions (MAX Z)

- Perform the **Resistance Test** and the **Insulation Test** to collect values into the Temporary Memory or clear the previous Resistance and Insulation test data by pressing **F1** & **F2** together.
- Start the MOTOR GENIE Test. Press **OK** to proceed to the Real time measurement screen.  
If needed, change the Test Frequency by pressing **MENU** or skip this step to keep 200Hz test frequency. Do not use 800Hz for the **Rotor Compensated Test** it will be changed to 400Hz for (I/F) measurement.
- Slowly rotate the rotor for a full turn. Watch for the maximum Impedance indicated in (**MaxZ**) field.  
If you have any doubts about (**MaxZ**) value press **F1** to reset it to zero and rotate the rotor again.  
Position the rotor so the real time Impedance value matching the value in (**MaxZ**) field. **①⑥⑪**  
**Leave the rotor in this position.**  
Press **TEST**, **②⑦⑫** this will save Impedance (Z) and (**MaxZ**) values into Temporary Memory and switch the measurement to Current Frequency Response (I/F).
- Wait until the (I/F) value is stable (do not change the rotor position).  
Press **TEST**, **③⑧⑬** to save the (I/F) value and switch measurement to Phase Angle ( $\psi$ ).
- Wait until the ( $\psi$ ) value is stable (do not change the rotor position).  
If the current phase is (T1-T2) or (T1---T3) then press **TEST**, **④⑨** to to save the ( $\psi$ ) value and switch back to the Impedance (Z). Press **F2**, **⑤⑩** to switch to the next phase, proceed to step III.  
If the current phase is (T2-T3) then you finished all measurements. Press **OK**, **⑭** to save the (T2-T3) ( $\psi$ ) value and proceed to the Result screen. (**Exit**). **Rotor Compensated Test complete.**



## 8.5 Cable Testing Instructions

1. Attach the test leads to one end of the cable. *Twist, wind, or tie* the opposite cable ends together and perform the R resistance test.
2. Connect the Black lead to one of the cables, the blue to another, and the red lead to the third cable. Use the Resistance measurement to check for opens, breaks or partial breaks in the conductors.
3. Review the data and look for any deviations (even very small variances) in the resistance values to indicate damaged strands.
4. With the same connections, use the MG test function to evaluate the condition of the insulation surrounding the cables.
5. Review the results and again look for small deviations in the results from the Z,  $\psi$  or I/F tests to indicate damage.

## 9. Manual Test Mode



The manual mode is located in the SET ICON.

Manual Test Mode is used to individually test the R,  $\psi$ , I/F or Z of coils or windings in motors and also other electrical machinery or components, such as conductors, insulators, resistors, switches & fuses.

The manual test mode operates similarly to the 3 motor tests (R, I & Winding Insulation Test), where on-screen instructions guide the user through the testing processes.

The manual mode measures and displays  $\psi$ , I/F or Z at 50, 100, 200 & 400 Hz.

**NOTE:** *The measurements performed in the manual mode can't be saved in the instrument memory and must be manually recorded or use a mobile device to capture the results. If the results require saving use the MOTOR GENIE TEST for a single test lead.*

### **Precise and Accurate Very Low Resistance Measurement**

Since the Motor Genie uses a four-wire Kelvin measure system, it makes it possible to accurately perform the very precise resistance measurements while eliminating the need to calibrate or compensate for the resistance of the test leads. This means the Motor Genie can be used to quickly perform resistance measurements that require precise and accurate measurements.

### **Test a Switch (Locate pitted, corroded, or loose contactors)**

Manual Resistance measurements can be used to locate pitted, corroded, or loose contactors. This measurement is made with the contactors in the closed position. The resistance across the closed contactors should be balanced, and very low.

### **Test Fuse Resistance (Locate high resistance fuses)**

The fuses inherently have low resistance, in three phases circuits all three fuses should have the same resistance.

### **Calibration**

Generally, the Motor Genie relies on relative measurements for evaluation of a motor's winding condition. Nevertheless, the recommended **calibration period is one year**.

The *Motor Genie Calibration Manual* can be found at <https://motorgenie.com>.



## 10. Condition Calculator App

The **ALL-TEST Pro Motor Genie app** is available for download to your mobile phone for Android® and Apple®.

### Using the App

Step 1: Press top button that says “add New Test”

Step 2: Enter measurements in corresponding fields in the measured variable (Starts with Resistance).

Step 3: View results

Step 4: Email report to yourself and or others who need the data.

### Retesting the same motor?

Step 1: Locate and select the motor you wish to enter a new test for in the saved test data by motor identification.

Step 2: Select the last test for the motor identification and hit the red circle that says “Test Again”.

Step 3: Enter new test results.

Motor data entry of measurements:



Condition Calculator Report from MG App:

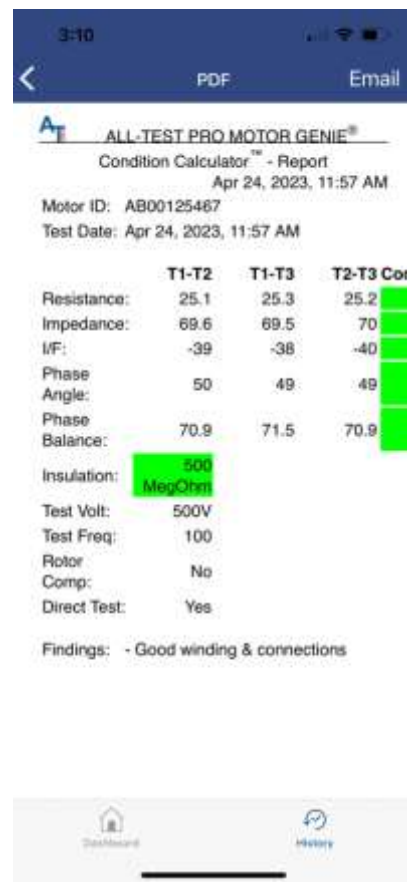



## 10.1 Mapping Test Data to the App

ALL-TEST PRO MOTOR GENIE application available for download for Android® and Apple® devices.

The diagram illustrates the mapping of test data from a physical device to the Motor Analysis app. The physical device data is organized into several sections, each corresponding to a specific measurement in the app.

Measurement	Value 1	Value 2	Value 3	Conclusion
Resistance (R)	25.4Ω	25.4Ω	25.4Ω	0.0
Resistance Deviation (Rdev)	0.00%	0.00%	0.00%	-
Impedance (Z)	64.9Ω	67.2Ω	66.5Ω	1.96
Impedance Deviation (Zdev)	1.96%	1.51%	0.45%	-
I/F	-38%	-38%	-38%	0.0
I/F Deviation (ΔI/F)	0.00%	0.00%	0.00%	-
Phase Angle (φ)	47.8°	48.7°	48.3°	0.9
Phase Balance (pb)	0.3	0.1	0.0	0.3
Phase Balance Deviation (Δφ)	0.90°	0.40°	0.50°	-
Insulation Resistance	>5.00GΩ	-	-	5000 MegaOhm
Test Voltage	@ 500V	-	-	500V
Test Frequency	200Hz	-	-	200 Hz

The app interface, titled "Motor Analysis", displays the following data for Motor ID "Motor1":

- Resistance:** T1-T2: 25.4, T1-T3: 25.4, T2-T3: 25.4, Conclusion: 0.0
- Impedance(Z):** T1-T2: 64.9, T1-T3: 67.2, T2-T3: 66.5, Conclusion: 1.96
- I/F:** T1-T2: -38, T1-T3: -38, T2-T3: -38, Conclusion: 0.0
- Phase Angle(φ):** T1-T2: 47.8, T1-T3: 48.7, T2-T3: 48.3, Conclusion: 0.9
- Phase Balance(pb):** T1-T2: 0.3, T1-T3: 0.1, T2-T3: 0.0, Conclusion: 0.3
- Insulation Resistance:** 5000 MegaOhm
- Test Volt:** 500V (selected), 1000V
- Test Frequency:** 200 Hz
- Rotor Compensated:**
- Direct Test At Motor:**
- Findings:** (Empty)

## **11. Troubleshooting**

### **Charging**

If the unit does not fully charge, the batteries fell below the minimum charge. The first charge will bring the batteries back to the minimum level. To generate a full charge, disconnect the instrument from DC charger, then reconnect the instrument and start a new charge that will bring the instrument charge to the full status.

### **Overwriting Saved Data**

To overwrite previously saved data, simply save a new test record in the same memory slot. The instrument does not have a delete function.

### **Power On/Off**

If the instrument does not turn on, the most likely cause would be that the Li-ION batteries built-in over discharge protection circuits have switched off, resulting in no power. The solution is to connect the charger to the instrument to recharge the batteries.

### **Keypad**

Simultaneously press the right and left arrow keys for a few seconds and then release ← and →. This will perform a forced hardware & firmware reset and will return the display back to the main menu. (Any saved test data stored into the instrument's memory will not be lost when this reset is performed). Only reset instrument if function keys on keypad are inoperable.

### **No Connection**

Instrument will beep, check the test lead connections to ensure they are in good working condition and properly connected to the instrument. Ensure that the test leads are securely connected to the cable or lead being tested. A display error will indicate the connection issue. Fix the connection issue and the instrument will begin the test automatically.

## **12. Available Upgrades**

### **Firmware Upgrade**

ATP updates its device firmware periodically to maintain optimal motor testing accuracy. This device can have its firmware upgraded remotely. Please contact [support@alltestpro.com](mailto:support@alltestpro.com) for more information.

## **13. Glossary**

**R** - Resistance is the Direct Current resistance measured in  $\Omega$  (Ohm).

**I/F** - is the percent reduction in current flow when the applied frequency is exactly doubled.

*I/F test the low voltage AC signal is applied to the connected winding/windings, at a specific frequency and the resultant current is measured. The frequency of the applied AC signal is then doubled, and the resultant current is again measured. Value is displayed as a percent difference.*

**Z** - Impedance is the complex resistance in a coil or winding. Impedance includes resistance, inductive reactance, and capacitive reactance. Impedance is measured in  $\Omega$  (Ohm).

**Fi** - Phase Angle is a relative measurement that indicates the angular difference between two waveforms of the same frequency. The results are expressed in degrees angular difference (0 – 90). Phase angle (Fi) is the amount of lag between the applied voltage and the resulting current in the basic motor circuit and is used to detect winding faults in the motor circuit.

**Ψ** - Phase Balance calculates the impedance unbalance between stator phases. Unbalanced phases require higher current to provide the overall torque, that creates additional heating of the stator windings thus reducing the longevity of the stator winding's insulation.

**INS** - Insulation (to Ground) Test. Measured in Meg-Ohm

## **14. Contact Information**

<b>Phone</b>	+1 860-399-4222
<b>Fax</b>	+1 860-399-3180
<b>Email</b>	<a href="mailto:sales@alltestpro.com">sales@alltestpro.com</a>
<b>Website</b>	<a href="https://alltestpro.com">https://alltestpro.com</a>
<b>Mailing Address</b>	<b>ALL-TEST Pro, LLC</b> 20 Research Parkway, Suite G Old Saybrook, CT 06475 USA

## **15. Notice of Service/Trademark Rights**

The trademarks, service marks and logos (collectively, the Marks) set forth below are registered and unregistered trademarks and/or service marks owned by ALL-TEST Pro, LLC in the United States and certain other countries throughout the world. Nothing contained in this manual should be construed as granting, by implication, estoppels or otherwise, any license or right to use any of the Marks without the written permission of ALL-TEST Pro, LLC.

Any misuse of the Marks or any Content, except as provided in this Statement, is strictly prohibited, and may violate trademark laws.

Other brands or product names used in this manual are trademarks and/or service marks of their respective owners, should be treated as such, and may be registered in various jurisdictions.

ALL-TEST PRO® is a Registered Trademark of ALL-TEST Pro, LLC

ALL-TEST PRO MOTOR GENIE MCA™, AT34™, AT7™ & AT7 Professional™, MOTOR GENIE MCA™ are all Trademarks of ALL- TEST Pro, LLC.

Disclaimer: Documents published by ALL-TEST Pro, LLC are provided as is without warranty of any kind, either expressed, implied or statutory, including, but not limited to any warranties of merchantability, fitness for a particular purpose, or non-infringement.

ALL-TEST Pro, LLC shall not under any circumstances be liable to any person for any special, incidental, indirect or consequential damages, including, without limitation damages resulting from use of or reliance on the information presented, loss of profits or revenues or costs of replacement goods, even if informed in advance of the possibility of such damages.

Reasonable efforts have been made to ensure the accuracy of the information presented. However, ALL-TEST Pro, LLC assumes no responsibility for the accuracy of the information. Product information is subject to change without notice. ALL-TEST Pro, LLC may make improvements and/or changes in the products and/or the programs described in these publications at any time without notice.

You may cite or refer to information published in this manual, except as provided below, but you may not reproduce or distribute such information in whole or in part without the prior written permission of ALL-TEST Pro, LLC. You may not reproduce or distribute any image from the Manual, without securing advance written consent from ALL-TEST Pro, LLC. To request such permission, send email to [info@alltestpro.com](mailto:info@alltestpro.com), including your name, address, and a description of the purpose of your intended distribution and the information you would like to distribute.

You may print, reproduce, and use the information in, and retrieve files containing software or images from ALL-TEST Pro, LLC for non-commercial, personal, or educational purposes only, provided that you (i) do not modify such information, and (ii) include any copyright originally included with such information and this notice in all such copies.

Nothing contained herein shall be construed as conferring by implication or otherwise any license or right under any patent or trademark of ALL-TEST Pro, LLC or any third party. No other rights under any copyrights of ALL-TEST Pro, LLC or any other party are granted herein, except as expressly stated above.

Information in this document ©2023 ALL-TEST Pro, LLC All rights reserved.